

# FLOOR SCREEN BOOTH 50 SQUARE



**KURAGE**

01-2023

# FLOOR SCREEN BOOTH 50 SQUARE



## SPECIFICATIONS

Booths are supplied in various combination possibilities, all with a height of 140-155 cm.

The cover has elastics sewn on, ensuring a constant tightening of the fabric.

Cover is detachable and can be dry-cleaned.

Possibility for printed as well as plain textiles.

Visible frame of extruded aluminium.

Acoustic core of stone wool/mineral wool made from natural minerals.

Thickness: 54 mm.

In addition to standard dimensions we also supply special dimensions.

# FLOOR SCREEN BOOTH 50 SQUARE

## COMBINATIONS

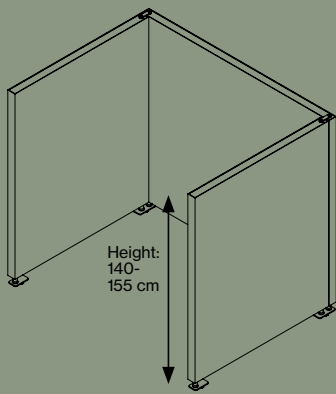

Type A

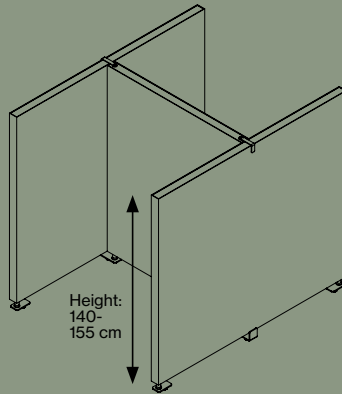

Type B

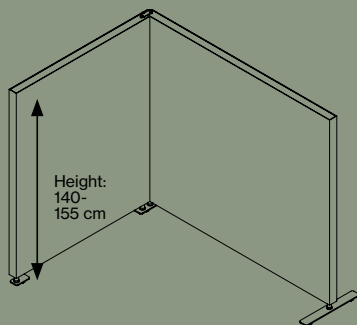

Type C

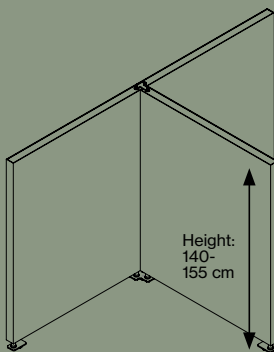

Type D

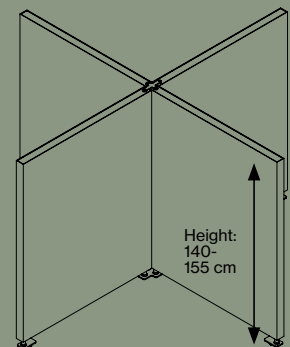

Type E

# FLOOR SCREEN BOOTH 50 SQUARE

## ACOUSTIC PROPERTIES

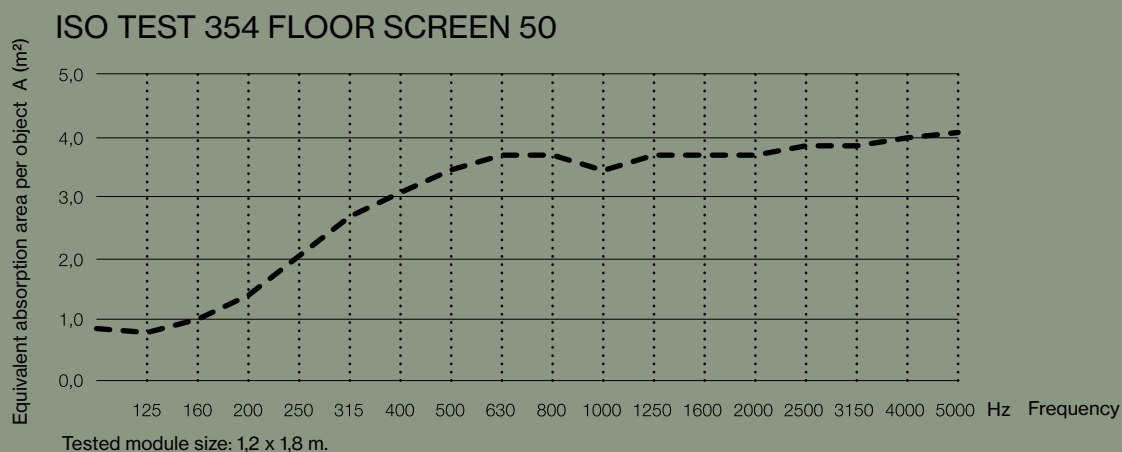

# FLOOR SCREEN BOOTH 50 SQUARE

## ACCESSORIES 1/2

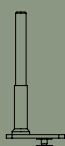

Adjustable foot  
article no. 5220

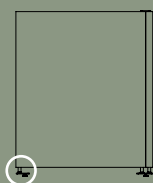

Adjustable foot  
article no. 5220

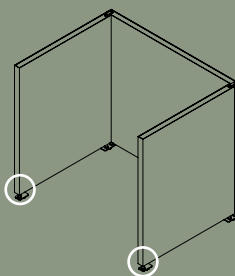

Adjustable foot  
article no. 5220

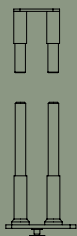

Connecting bracket  
article no. 5221

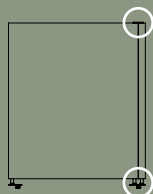

Connecting bracket  
article no. 5221

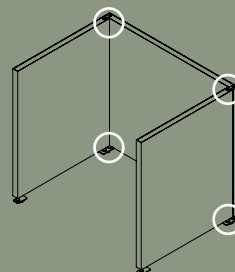

Connecting bracket  
article no. 5221



Connecting bracket  
article no. 5222

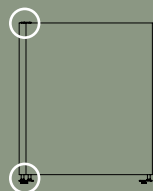

Connecting bracket  
article no. 5222

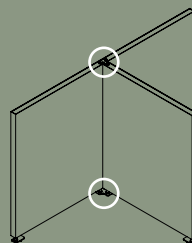

Connecting bracket  
article no. 5222

# FLOOR SCREEN BOOTH 50 SQUARE

## ACCESSORIES 2/2

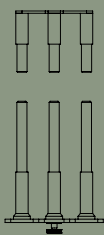

Connecting bracket  
article no. 5223

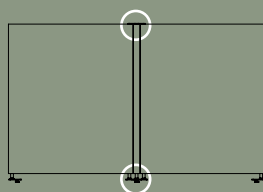

Connecting bracket  
article no. 5223

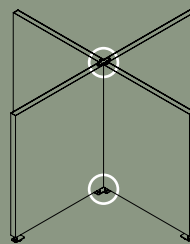

Connecting bracket  
article no. 5223



Connecting bracket  
article no. 5224

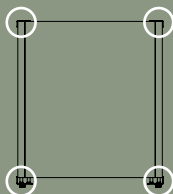

Connecting bracket  
article no. 5224

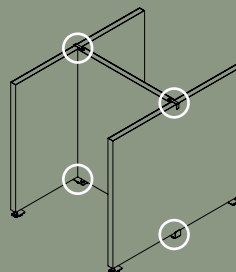

Connecting bracket  
article no. 5224

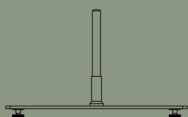

Square adjustable foot  
article no. 5021

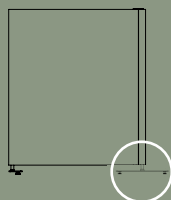

Square adjustable foot  
article no. 5021

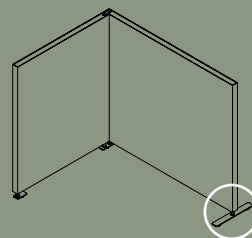

Square adjustable foot  
article no. 5021